



## **SIOV metal oxide varistors**

Leaded varistors, SuperioR, S25 series

**Series/Type:** S25

**Date:** December 2007

## Leaded varistors

### SuperioR, S25 series

#### Construction

- Round varistor element, leaded
- Coating: epoxy resin, flame-retardant to UL 94 V-0
- Terminals: tinned copper wire

#### Features

- High-energy SuperioR series E4
- Wide operating voltage range 130 ... 750 V<sub>RMS</sub>
- UL approval to UL 1449 (file number E97877 – exception 580 V)
- Very high surge current rating up to 20 kA

#### Approvals

- UL
- CSA

#### Delivery mode

- Bulk (standard)
- For further details refer to chapter “Taping, packaging and lead configuration” for leaded varistors.

#### General technical data

Climatic category	to IEC 60068-1	40/85/56	
Operating temperature	to CECC 42 000	–40 ... + 85	°C
Storage temperature		–40 ... +125	°C
Electric strength	to CECC 42 000	≥2.5	kV <sub>RMS</sub>
Insulation resistance	to CECC 42 000	≥10	MΩ
Response time		<25	ns

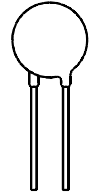
**Leaded varistors**
**SuperioR, S25 series**
**Maximum ratings** ( $T_A = 85\text{ °C}$ )

Ordering code	Type (untaped) SIOV-	$V_{RMS}$	$V_{DC}$	$i_{max}$ (8/20 $\mu$ s)	$W_{max}$ (2 ms)	$P_{max}$
		V	V	A	J	W
B72225S4131K101	S25K130E4R12	130	170	20000	185	1.0
B72225S4141K101	S25K140E4R12	140	180	20000	195	1.0
B72225S4151K101	S25K150E4R12	150	200	20000	215	1.0
B72225S4171K101	S25K175E4R12	175	225	20000	245	1.0
B72225S4231K101	S25K230E4R12	230	300	20000	315	1.0
B72225S4251K101	S25K250E4R12	250	320	20000	345	1.0
B72225S4271K101	S25K275E4R12	275	350	20000	375	1.0
B72225S4301K101	S25K300E4R12	300	385	20000	410	1.0
B72225S4321K101	S25K320E4R12	320	420	20000	445	1.0
B72225S4381K101	S25K385E4R12	385	505	20000	600	1.0
B72225S4421K101	S25K420E4R12	420	560	20000	700	1.0
B72225S4441K101	S25K440E4R12	440	585	20000	710	1.0
B72225S4461K101	S25K460E4R12	460	615	20000	720	1.0
B72225S4511K101	S25K510E4R12	510	670	20000	750	1.0
B72225S4551K101	S25K550E4R12	550	745	20000	780	1.0
B72225S4581K101	S25K580E4R12	580	780	20000	800	1.0
B72225S4621K101	S25K625E4R12	625	825	20000	855	1.0
B72225S4681K101	S25K680E4R12	680	895	20000	940	1.0
B72225S4751K101	S25K750E4R12	750	1060	20000	1025	1.0

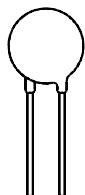

Leaded varistors

SuperioR, S25 series

Characteristics ( $T_A = 25\text{ °C}$ )

Ordering code	$V_V$ (1 mA) V	$\Delta V_V$ (1 mA) %	$V_{c, \max}$ ( $i_c$ ) V	$i_c$ A	$C_{typ}$ (1 kHz) pF
B72225S4131K101	205	$\pm 10$	340	150	2780
B72225S4141K101	220	$\pm 10$	360	150	2550
B72225S4151K101	240	$\pm 10$	395	150	2370
B72225S4171K101	270	$\pm 10$	455	150	2080
B72225S4231K101	360	$\pm 10$	595	150	1560
B72225S4251K101	390	$\pm 10$	650	150	1430
B72225S4271K101	430	$\pm 10$	710	150	1320
B72225S4301K101	470	$\pm 10$	775	150	1180
B72225S4321K101	510	$\pm 10$	840	150	1090
B72225S4381K101	620	$\pm 10$	1025	150	900
B72225S4421K101	680	$\pm 10$	1120	150	830
B72225S4441K101	715	$\pm 10$	1180	150	780
B72225S4461K101	750	$\pm 10$	1240	150	740
B72225S4511K101	820	$\pm 10$	1355	150	680
B72225S4551K101	910	$\pm 10$	1500	150	630
B72225S4581K101	940	$\pm 10$	1580	150	605
B72225S4621K101	1000	$\pm 10$	1650	150	565
B72225S4681K101	1100	$\pm 10$	1815	150	515
B72225S4751K101	1200	$\pm 10$	2000	150	480

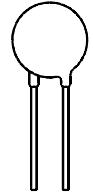

**Leaded varistors**  
**SuperioR, S25 series**

**Dimensional drawing**

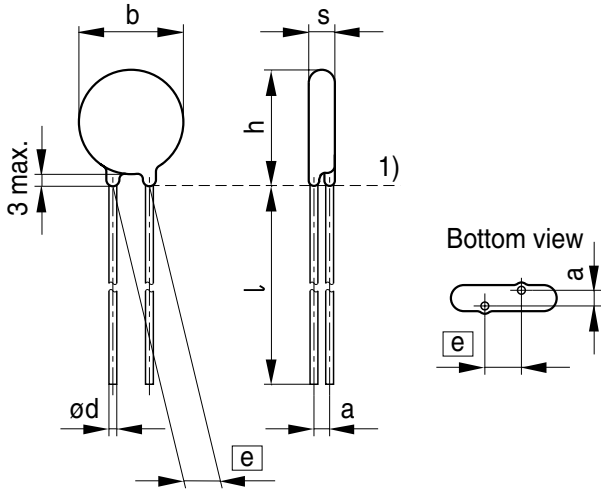

1) Seating plane to IEC 60717

VAR0408-C

**Weight**

Nominal diameter mm	V <sub>RMS</sub> V	Weight g
25	130 ... 750	5.4 ... 16.8

The weight of varistors in between these voltage classes can be interpolated.

**Dimensions**

Ordering code	$e \pm 1$ mm	$a \pm 1$ mm	$b_{max}$ mm	$s_{max}$ mm	$h_{max}$ mm	$l_{min}$ mm	$d \pm 0.05$ mm
B72225S4131K101	12.7	2.2	27.5	5.1	31.0	25.0	1.0
B72225S4141K101	12.7	2.3	27.5	5.2	31.0	25.0	1.0
B72225S4151K101	12.7	2.4	27.5	5.3	31.0	25.0	1.0
B72225S4171K101	12.7	2.6	27.5	5.4	31.0	25.0	1.0
B72225S4231K101	12.7	3.2	27.5	6.0	31.0	25.0	1.0
B72225S4251K101	12.7	3.4	27.5	6.2	31.0	25.0	1.0
B72225S4271K101	12.7	3.6	27.5	6.4	31.0	25.0	1.0
B72225S4301K101	12.7	3.9	27.5	6.7	31.0	25.0	1.0
B72225S4321K101	12.7	4.1	27.5	6.9	31.0	25.0	1.0
B72225S4381K101	12.7	4.8	27.5	7.6	31.0	25.0	1.0
B72225S4421K101	12.7	5.1	27.5	7.9	31.0	25.0	1.0
B72225S4441K101	12.7	5.4	27.5	8.1	31.0	25.0	1.0
B72225S4461K101	12.7	5.6	27.5	8.3	31.0	25.0	1.0
B72225S4511K101	12.7	6.0	27.5	8.7	31.0	25.0	1.0
B72225S4551K101	12.7	6.5	27.5	9.2	31.0	25.0	1.0
B72225S4581K101	12.7	6.7	27.5	9.4	31.0	25.0	1.0
B72225S4621K101	12.7	7.1	27.5	9.8	31.0	25.0	1.0
B72225S4681K101	12.7	7.7	27.5	10.4	31.0	25.0	1.0
B72225S4751K101	12.7	8.2	27.5	10.9	31.0	25.0	1.0

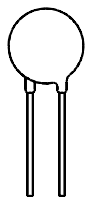
**Leaded varistors****SuperioR, S25 series****Reliability data**

Test	Test methods/conditions	Requirement
Varistor voltage	The voltage between two terminals with the specified measuring current applied is called $V_V$ (1 mA <sub>DC</sub> @ 0.2 ... 2 s).	To meet the specified value.
Clamping voltage	The maximum voltage between two terminals with the specified standard impulse current (8/20 $\mu$ s) applied.	To meet the specified value.
Surge current derating, 8/20 $\mu$ s	CECC 42 000, test C 2.1 100 surge currents (8/20 $\mu$ s), unipolar, interval 30 s, amplitude corresponding to derating curve for 100 impulses at 20 $\mu$ s	$ \Delta V/V (1 \text{ mA})  \leq 10\%$ (measured in direction of surge current) No visible damage
Surge current derating, 2 ms	CECC 42 000, test C 2.1 100 surge currents (2 ms), unipolar, interval 120 s, amplitude corresponding to derating curve for 100 impulses at 2 ms	$ \Delta V/V (1 \text{ mA})  \leq 10\%$ (measured in direction of surge current) No visible damage

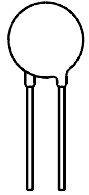

**Leaded varistors**  
**SuperioR, S25 series**

**v/i characteristics**

$v = f(i)$  – for explanation of the characteristics refer to “General technical information”, 1.6.3

A = Leakage current  
B = Protection level

{ for worst-case varistor tolerances

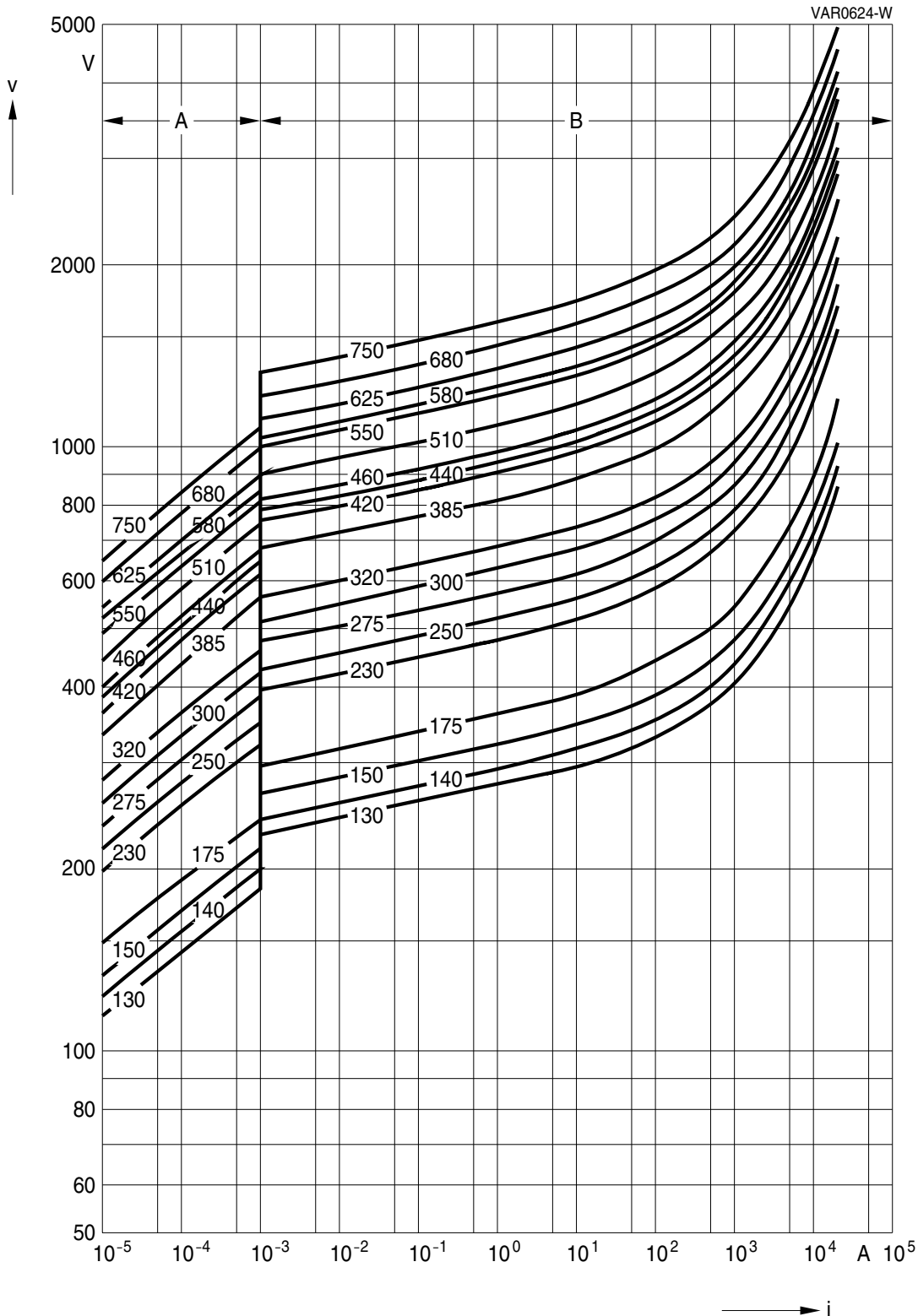

**SIOV-S25 ... E4R12**

Please read *Cautions and warnings* and *Important notes* at the end of this document.

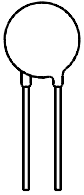

**Leaded varistors**

**SuperioR, S25 series**

**Derating curves**

Maximum surge current  $i_{max} = f(t_r, \text{pulse train})$

For explanation of the derating curves refer to "General technical information", section 1.8.1

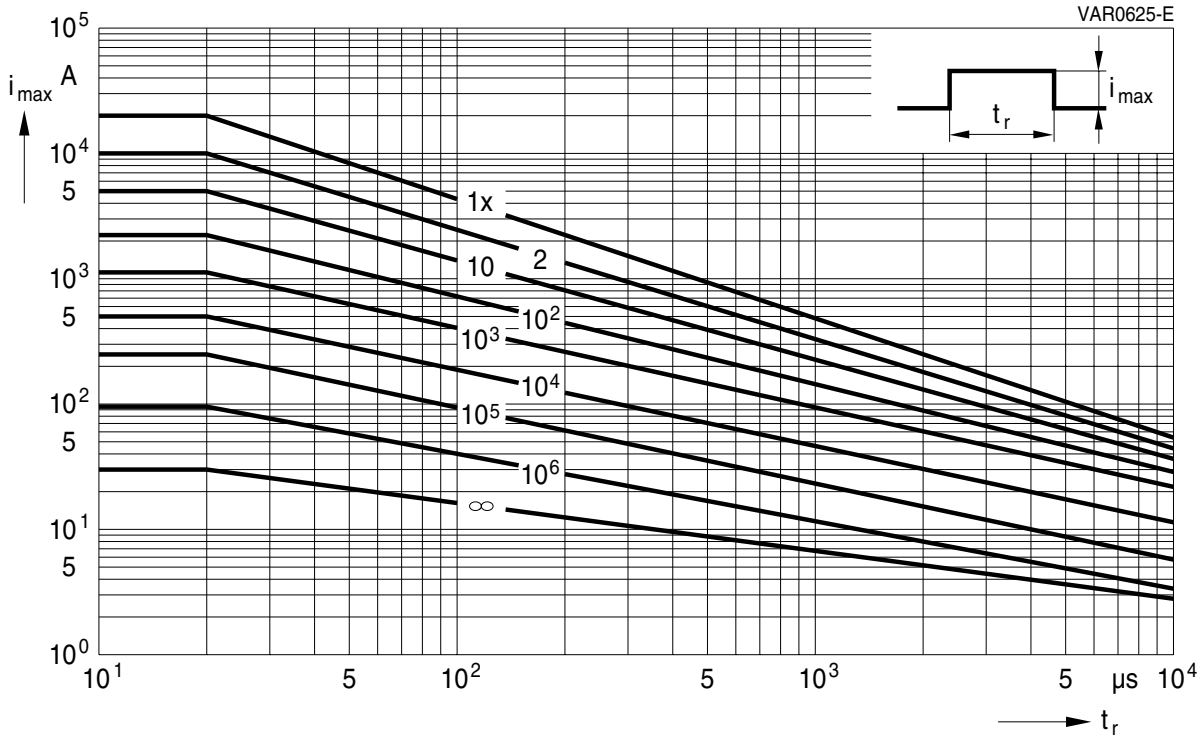

**SIOV-S25 ... E4R12**

## Cautions and warnings

### General

1. EPCOS metal oxide varistors (SIOVs) are designed for specific applications and should not be used for purposes not identified in our specifications, application notes and data books unless otherwise agreed with EPCOS during the design-in-phase.
2. Ensure suitability of SIOVs through reliability testing during the design-in phase. SIOVs should be evaluated taking into consideration worst-case conditions.
3. For applications of SIOVs in line-to-ground circuits based on various international and local standards there are restrictions existing or additional safety measures required.

### Storage

1. Store SIOVs only in original packaging. Do not open the package before storage.
2. Storage conditions in original packaging:  
Storage temperature:  $-25\text{ °C} \dots +45\text{ °C}$   
Relative humidity:  $<75\%$  annual average,  
 $<95\%$  on maximum 30 days a year.  
Dew precipitation: Is to be avoided.
3. Avoid contamination of an SIOV's surface during storage, handling and processing.
4. Avoid storage of SIOVs in harmful environments that can affect the function during long-term operation (examples given under operation precautions).
5. The SIOV type series should be soldered within the time specified:  
SIOV-S, -Q, -LS      24 months  
ETFV and SFS types   12 months.

### Handling

1. SIOVs must not be dropped.
2. Components must not be touched with bare hands. Gloves are recommended.
3. Avoid contamination of the surface of SIOV electrodes during handling, be careful of the sharp edge of SIOV electrodes.

### Soldering (where applicable)

1. Use rosin-type flux or non-activated flux.
2. Insufficient preheating may cause ceramic cracks.
3. Rapid cooling by dipping in solvent is not recommended.
4. Complete removal of flux is recommended.

## Leaded varistors

### SuperioR, S25 series

#### Mounting

1. Potting, sealing or adhesive compounds can produce chemical reactions in the SIOV ceramic that will degrade the component's electrical characteristics.
2. Overloading SIOVs may result in ruptured packages and expulsion of hot materials. For this reason SIOVs should be physically shielded from adjacent components.

#### Operation

1. Use SIOVs only within the specified temperature operating range.
2. Use SIOVs only within the specified voltage and current ranges.
3. Environmental conditions must not harm SIOVs. Use SIOVs only in normal atmospheric conditions. Avoid use in the presence of deoxidizing gases (chlorine gas, hydrogen sulfide gas, ammonia gas, sulfuric acid gas, etc), corrosive agents, humid or salty conditions. Avoid contact with any liquids and solvents.

## Important notes

The following applies to all products named in this publication:

1. Some parts of this publication contain **statements about the suitability of our products for certain areas of application**. These statements are based on our knowledge of typical requirements that are often placed on our products in the areas of application concerned. We nevertheless expressly point out **that such statements cannot be regarded as binding statements about the suitability of our products for a particular customer application**. As a rule, EPCOS is either unfamiliar with individual customer applications or less familiar with them than the customers themselves. For these reasons, it is always ultimately incumbent on the customer to check and decide whether an EPCOS product with the properties described in the product specification is suitable for use in a particular customer application.
2. We also point out that **in individual cases, a malfunction of passive electronic components or failure before the end of their usual service life cannot be completely ruled out in the current state of the art, even if they are operated as specified**. In customer applications requiring a very high level of operational safety and especially in customer applications in which the malfunction or failure of a passive electronic component could endanger human life or health (e.g. in accident prevention or life-saving systems), it must therefore be ensured by means of suitable design of the customer application or other action taken by the customer (e.g. installation of protective circuitry or redundancy) that no injury or damage is sustained by third parties in the event of malfunction or failure of a passive electronic component.
3. **The warnings, cautions and product-specific notes must be observed.**
4. In order to satisfy certain technical requirements, **some of the products described in this publication may contain substances subject to restrictions in certain jurisdictions (e.g. because they are classed as hazardous)**. Useful information on this will be found in our Material Data Sheets on the Internet ([www.epcos.com/material](http://www.epcos.com/material)). Should you have any more detailed questions, please contact our sales offices.
5. We constantly strive to improve our products. Consequently, **the products described in this publication may change from time to time**. The same is true of the corresponding product specifications. Please check therefore to what extent product descriptions and specifications contained in this publication are still applicable before or when you place an order. We also **reserve the right to discontinue production and delivery of products**. Consequently, we cannot guarantee that all products named in this publication will always be available. The aforementioned does not apply in the case of individual agreements deviating from the foregoing for customer-specific products.
6. Unless otherwise agreed in individual contracts, **all orders are subject to the current version of the “General Terms of Delivery for Products and Services in the Electrical Industry” published by the German Electrical and Electronics Industry Association (ZVEI)**.
7. The trade names EPCOS, BAOKE, Alu-X, CeraDiode, CSSP, DSSP, MiniBlue, MKK, MLSC, MotorCap, PCC, PhaseCap, PhaseMod, SIFERRIT, SIFI, SIKOREL, SilverCap, SIMDAD, SIMID, SineFormer, SIOV, SIP5D, SIP5K, ThermoFuse, WindCap are **trademarks registered or pending** in Europe and in other countries. Further information will be found on the Internet at [www.epcos.com/trademarks](http://www.epcos.com/trademarks).